

DROPS Design®

www.garnstudio.com

Fall Festival by DROPS Design

Crochet DROPS jacket worked in a circle in "Big Delight". Size: S - XXXL.

DROPS design: Pattern no db-065

Yarn group C or A + A

Size: S/M - L/XL - XXL/ XXXL

Materials:

DROPS BIG DELIGHT from Garnstudio

500-600-700 g color no 06, fall forest

DROPS CROCHET HOOK SIZE 5.5 mm/US 9 – or size needed to get 13 dc x 8 rows = 4" x 4" (10 x 10 cm).



DROPS 171-21

Yarn prices (per 24.03.2020)

Yarn (weight)	Content	United States
DROPS Big Delight print (100g)	100% Wool	7.80 USD

 You can get the yarn to make this pattern from **39.00\$***.

(*) Pattern prices are calculated from the smallest size / cheapest colour. You will find a prices table in this print to help you calculate the price for other sizes.

All yarns are DROPS yarns. Color charts and updated retailer lists at www.garnstudio.com

Pattern for DROPS 171-21

PATTERN:

See diagrams A.1 to A.5.

CROCHET INFO:

Replace first sc at beg of round with ch 1, finish round with 1 sl st in 1st ch at beg of round.

Replace first dc at beg of round with ch 3, finish round with 1 sl st in 3rd ch from beg of round.

Replace first tr at beg of round with ch 4, finish round with 1 sl st in 4th ch from beg of round.

JACKET WORKED IN A CIRCLE:

Crochet 4 ch on hook SIZE 5.5 mm/US 9 with Big Delight and form a ring with 1 sl st in first ch. Then work according to A.1. **READ CROCHET INFO! REMEMBER THE CROCHET GAUGE!** When A.1 has been worked, circle measures approx. 33 cm / 13" in diameter and there are 27 tr-groups on round.

Size L/XL-XXL/XXXL: Work according to A.2, on first round in A.2 inc 9 ch-spaces evenly (inc the same way as on 6th round in A.1, inc 1 ch-space as follows: Work 1 sc around ch-space in the middle of tr-group, 9 ch, 1 sc around ch between tr-groups, 9 ch, 1 sc around ch-space in the middle of next tr-group) = 36-36 ch-spaces. Work A.2 1 time vertically.

ALL SIZES: = 27-36-36 tr-groups. Work next round as round 1 in A.3, **AT THE SAME TIME** work armholes as follows:

1 sc around ch-space in the middle of tr-group, work 30-33-36 loose ch, skip 5-6-7 tr-groups, 1 sc around ch-space in the middle of next tr-group (armhole has been worked), * 12 ch, 1 sc around ch-space in the middle of next tr-group *, repeat from *-* 8-14-12 times in total, work 30-33-36 loose ch, skip 5-6-7 tr-groups, 1 sc around ch-space in the middle of next tr-group (another armhole has been worked), * 12 ch, 1 sc around ch-space in the middle of next tr-group *, repeat from *-* the entire round and finish with 1 sl st in first sc at beg of round (instead of 1 sc around next ch-space).

Work next round as round 2 in A.3 as follows: Work the same way as before with 2 dc + 2 ch + 2 dc around every ch-space, around every ch-space for armhole work 6-7-8 dc-groups, **AT THE SAME TIME** inc 9 dc-groups evenly on round, inc 1 dc-group by working 2 dc + 2 ch + 2 dc + 2 dc + 2 ch + 2 dc around 1 ch-space = 36-45-45 dc-groups.

ROUND 3: Work 2 tr + 2 ch + 2 tr around ch-space in the middle of every dc-group and 1 ch between every tr-group = 36-45-45 tr-groups with 1 ch between each.

Continue to work according to A.3, **AT THE SAME TIME** inc 9 ch-spaces evenly every time 1st round is worked, as follows:

ROUND 1: Work sl sts until middle of first ch-space (in the middle of a tr-group), 1 sc, * 12 ch, 1 sc around next ch-space in the middle of a tr-group *, repeat from *-* the entire round **AT THE SAME TIME** inc 9 ch-spaces evenly on round = 45-54-54 ch-spaces (finish round with 6 ch

and 1 dtr in first sc at beg of round).

ROUND 2: Work 2 dc + 2 ch + 2 dc around every ch-space the entire round = 45-54-54 dc-groups.

ROUND 3: Work 2 tr + 2 ch + 2 tr around every ch-space in dc-group and 1 ch between every tr-group the entire round = 45-54-54 tr-group with 1 ch between each.

Repeat 1st-3rd round 3-3-4 more times, AT THE SAME TIME inc 9 ch-spaces every time 1st round is worked = 72-81-90 tr-group.

To get an oval shape on jacket work back and forth only over the bottom 47-54-61 tr-groups, do not work over the middle 25-27-29 tr-groups at the top of neck.

Beg from RS and repeat 1st-3rd row in A.3 as before 2 times in total (i.e. back is 6 rows longer vertically), to get a nice transition on every turn work as shown in A.4 and A.5, AT THE SAME TIME inc 7 ch-spaces every time 1st row is worked (= 86-95-104 tr-groups in total on round incl tr-groups towards the neck).

Finish with 1 round ch-spaces around the entire jacket (from RS) as follows: * ch 4, 1 sc around ch-space in the middle of a tr-group, ch 4, 1 sc before next tr-group *, repeat from *-* the entire round, fasten off.

SLEEVE:

Work 60-66-72 dc around armhole (approx. 5 dc in every tr-group and approx. 30-33-36 dc around ch-space – beg mid under sleeve).

Work next round as follows:

* 1 dc in first/next dc, ch 1, skip 1 dc *, repeat from *-* the entire round = 30-33-36 dc + 30-33-36 ch.

Continue to work as follows:

ROUND 1: * ch 6, skip 5 sts, 1 sc in next st *, repeat from *-* the entire round = 10-11-12 ch-spaces.

ROUND 2: Work 2 dc + 2 ch + 2 dc around every ch-space the entire round = 10-11-12 dc-groups.

ROUND 3: Work 2 tr + 2 ch + 2 tr around every ch-space in dc-group and 1 ch between every tr-group the entire round = 10-11-12 tr-group with 1 ch between each.

ROUND 4: * 12 ch, 1 sc around ch-space in the middle of tr-group *, repeat from *-* the entire round = 10-11-12 ch-spaces but at the same time dec 1 ch-space on round mid under sleeve as follows: 1 sc around ch-space in the middle of next to last tr-group on round, ch 6, 1 dc around ch-space in the middle of tr-group to be skipped, ch 6, 1 sc around ch-space in the middle of next tr-group). On new round work dc-group mid under sleeve in dc between the 2 ch-spaces with 6 ch = 9-10-11 dc-groups.

Repeat 2nd-4th round and dec at the same time 1 ch-space every 3rd round so that there is 1 tr-group/ch-space less on round. When there are 5-6-7 tr-groups/ch-spaces on round, work without dec until piece measures 54-54-56 cm / 21 1/4"-21 1/4"-22", or desired measurements, try the jacket while working. Fasten off and repeat on the other sleeve.

Diagram explanations

 = ch 4, 1 sl st in first ch (see point on circle), round beg and ends here

 = ch

 = sl st

 = work sl sts until the middle of first ch-space, 1 ch

 = sc around ch-space

 = dc around ch-space

 = dc in st

 = tr in st

 = dtr in st

 = 6 ch

 = 12 ch

 = 9 ch

 = 2 tr + 2 ch + 2 tr around ch-space in dc-group

 = ch 4, 1 tr + 2 ch + 2 tr around ch-space in dc-group

★ = round shows last round on previous diagram, round has already been worked

Diagram for DROPS 171-21

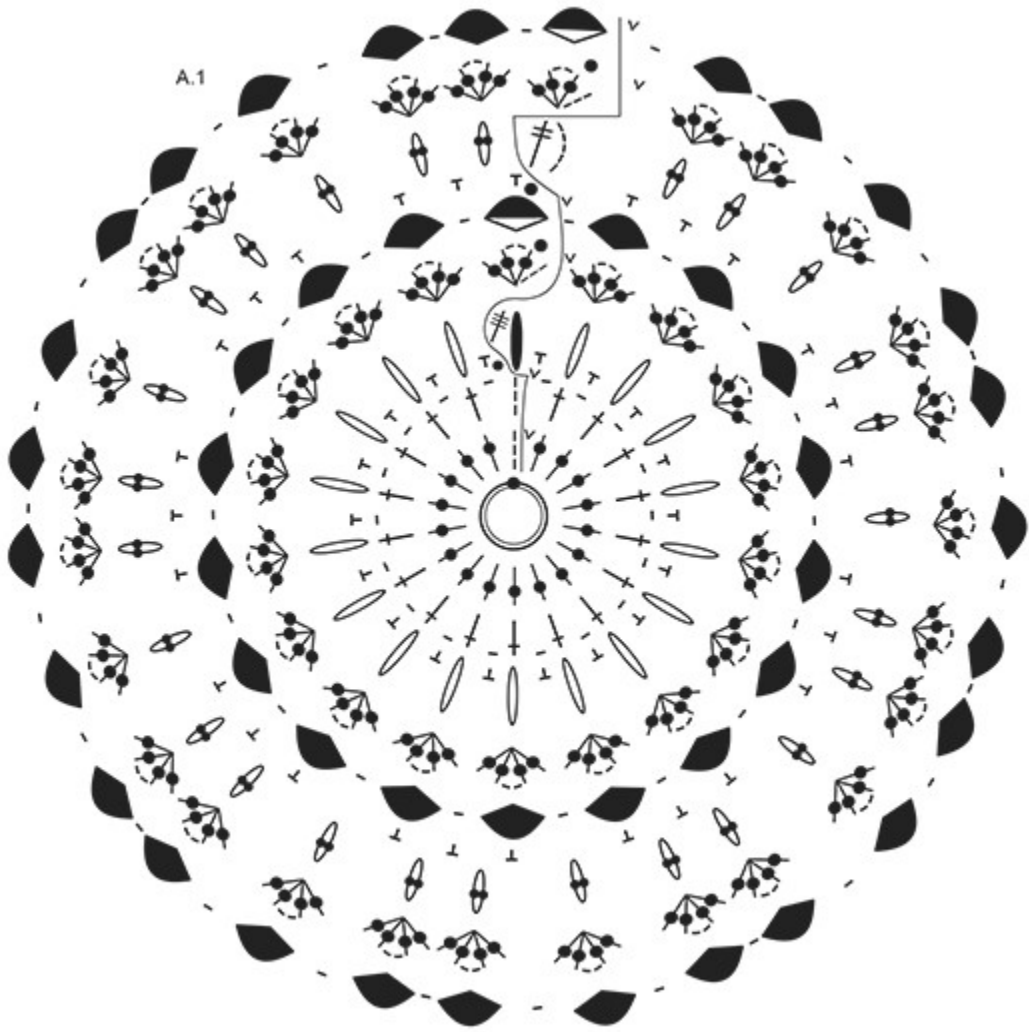

Diagram for DROPS 171-21

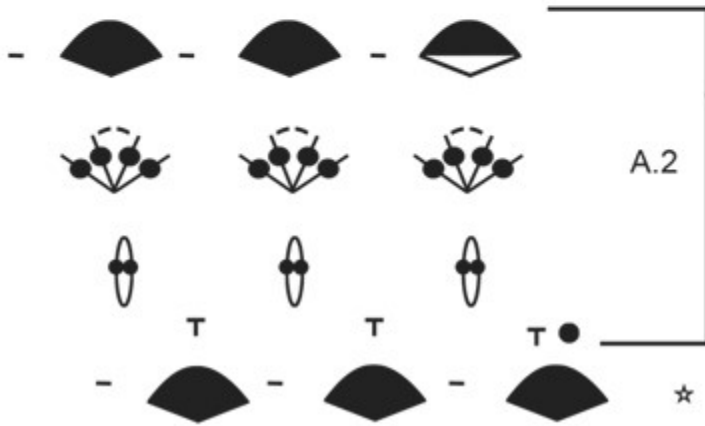
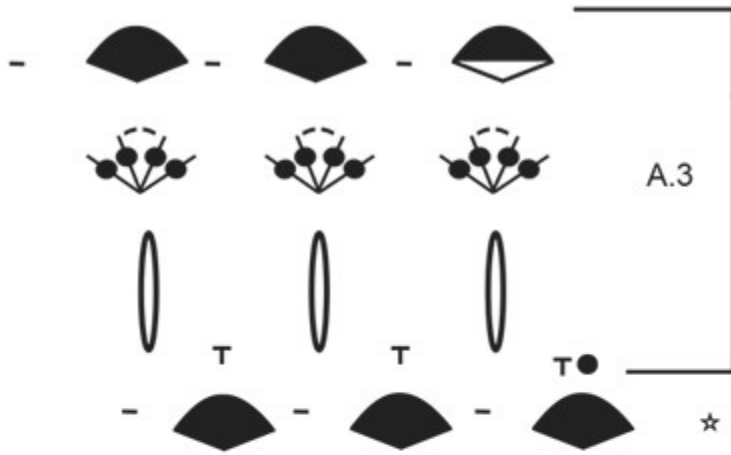

Diagram for DROPS 171-21

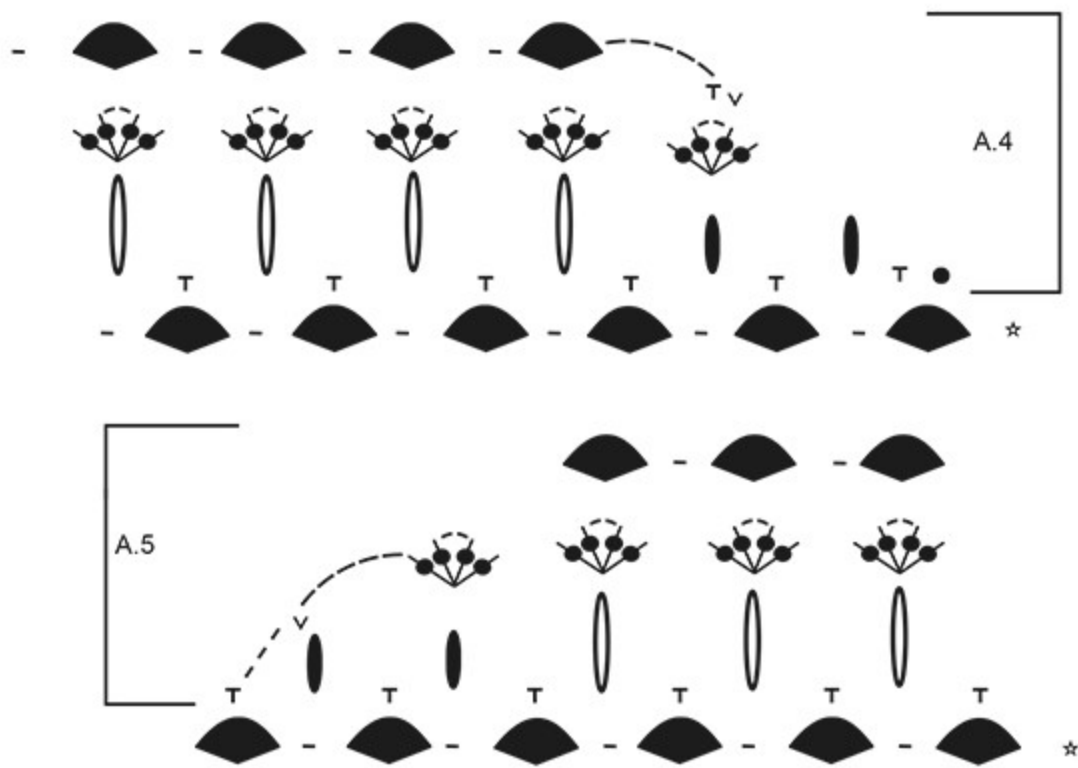
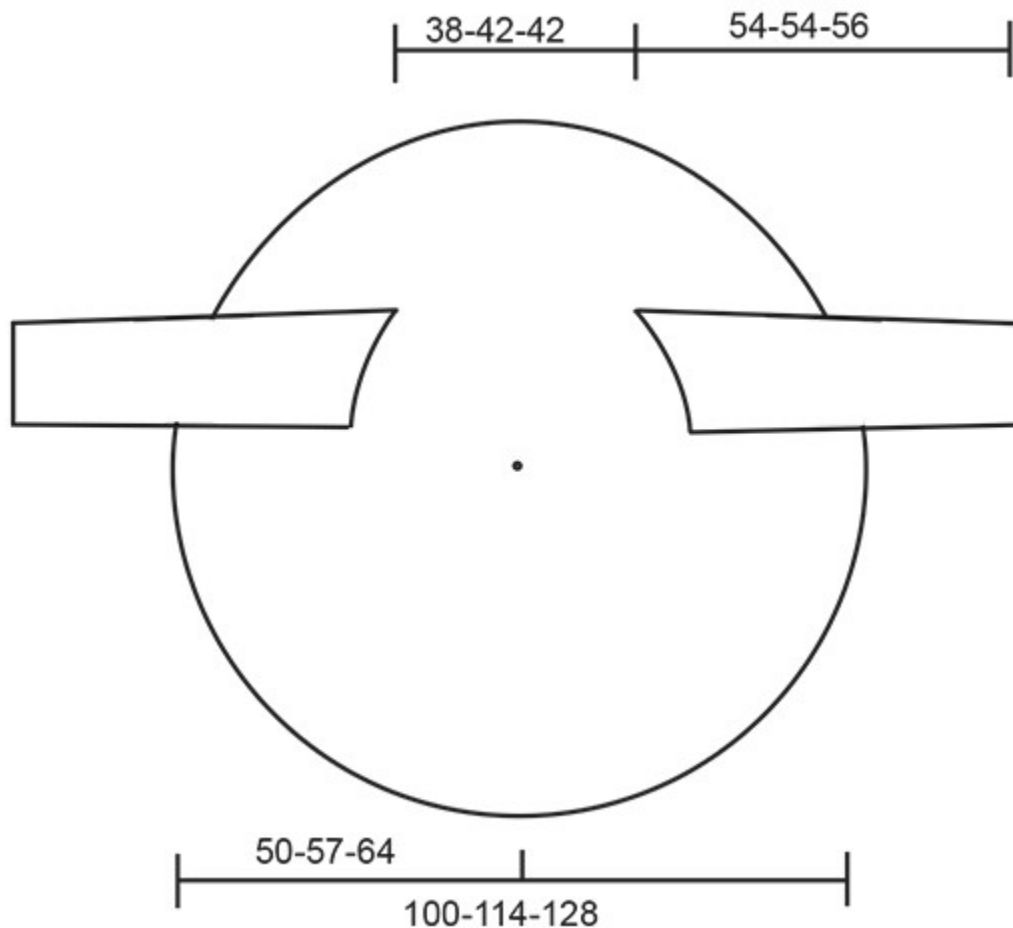
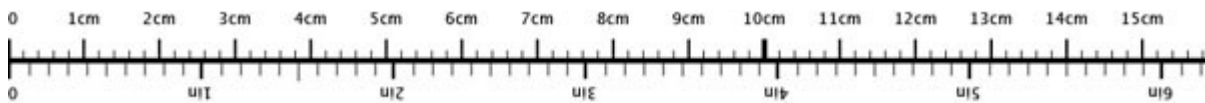

Diagram for DROPS 171-21



♥ Have you made this or any other of our designs? Tag your pictures in social media with #dropsdesign so we can see them!

Use me to measure your project!



To get the measurement tape to be 100 % accurate, you have to print out the pattern in full scale (and not use the print option "fit to page").

Do you need help with this pattern?

You'll find 7 tutorial videos, a Comments/Questions area and more by visiting the pattern on garnstudio.com. **Have you purchased DROPS yarn to make this pattern?** Then you are entitled to receive help from the store that sold you the yarn.

We take pride in providing patterns that are correct and easy to understand. All patterns are translated from Norwegian and you can always check the original pattern for measurements and calculations.

If we get a report of a potential error, we will review the pattern and make the correction if necessary. This will

be done normally within 7 to 10 working days. If no correction is made, it means that we weren't able to find any error/mistake.

Wondering where you can buy the yarn for this pattern?

Try a DROPS Super Store!

- Wool Warehouse Direct Ltd



DROPS
SOCK-A-LICIOUS

30% discount

DROPS NORD
MIX
Simply comfort in alpaca and wool

DROPS DELIGHT
PRINT
Superwash treated sock wool

DROPS Fabel
Print
Superwash treated sock wool

March 1st to 31st ✦ [garnstudio.com/sale](https://www.garnstudio.com/sale)



© 1982-2020 DROPS Design A/S. We reserve all rights. This document, including all its sub-sections, has copyrights. Read more about what you can do with our patterns at the bottom of each pattern on our site.