

Crochet for Kids
with
crochetme

5 FREE

**Crochet
Patterns
for Kids**

CROCHET FOR KIDS with **crochetme**
5 FREE Crochet Patterns for Kids



1 Sweetpea Cardigan

Candi Jensen

2 Stella Jacket

Heather Lodinsky

3 Toddler Poncho

Candi Jensen

4 Seashell and Posies Dress

Elissa Sugishita

5 Frog Charming

Toni Rexroat

CROCHET FOR KIDS with *crochetme*

5 FREE Crochet Patterns for Kids

KID'S CROCHETED PROJECTS are small and quickly finished; they are an ideal stash-busting project, using only a few balls of yarn, and the diminutive recipients are just old enough to appreciate the thought that goes into a handmade gift. Toddler garments are also the perfect canvas on which to try a new technique such as embroidery on a crocheted fabric or a new stitch pattern.

In this eBook, you will find a collection of 5 free kid's patterns, from a darling cardigan to a playful poncho. Use these free patterns to whip up an easy project that is sure to bring a smile to the child in your life.

The **Sweetpea Cardigan** by Candi Jensen is a sweet cardigan, embellished with embroidered ribbon flowers and a lace trim. The body of this easy cardigan is worked in single crochet, making it a great sweater project for a beginning crocheter. The little princess and the tomboy will both be enchanted by this sweater.

The **Stella Cardigan** by Robyn Chachula is a great transitional garment, moving from spring to fall with ease. Frog closures add a fun Asian flair and a pop of color to this unique toddler jacket. Visual crocheters will also find multiple stitch diagrams. This little cardigan is perfect for the girl who is one part mischief and one part sugar and spice.

The **Toddler Poncho** by Candi Jensen is worked in the round in a soft, warm washable wool. This easy project can be

completed in a weekend and makes a fun accessory for tiaras and gowns as well as jeans and dresses. Two large pom-poms accent the easy shell and bobble pattern.

The **Seashell and Posies Dress** by Elissa Sugishita is worked in a lacey shell pattern from the bottom up. Little girls will adore this toddler dress, which boasts a delicate flower trim at the waist; and you will love the minimal seaming—just two small shoulder seams.

Bring a touch of enchantment into a child's life with **Frog Charming** by Toni Rexroat. I was inspired by the story of the frog prince who fetched the princesses's favorite ball after it was lost down a well. This fun crocheted toy is perfect for a little boy or girl, a great project for any crocheter who loves amigurumi.

I hope you enjoy the free kid's crochet patterns in this eBook and share the joy of crochet with the kids in your life.

Best wishes,

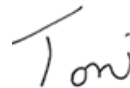

Toni
Editor, CrochetMe.com

1	Sweetpea Cardigan	
	Candi Jensen	PAGE 4
2	Stella Jacket	
	Heather Lodinsky	PAGE 8
3	Toddler Poncho	
	Candi Jensen	PAGE 14
4	Seashell and Posies Dress	
	Elissa Sugishita	PAGE 17
5	Frog Charming	
	Toni Rexroat	PAGE 21
	Stich Glossary	PAGE 24

crochetme

CROCHET FOR KIDS WITH CROCHET
ME: 5 FREE CROCHET PATTERNS FOR
KIDS FROM CROCHET ME

A Crochet Me eBook edited by
TONI REXROAT

EDITORIAL STAFF
EDITOR CROCHET ME Toni Rexroat

CREATIVE SERVICES
DESIGNER Charlene Tiedemann
PHOTOGRAPHY As noted
ILLUSTRATION Gayle Ford

Projects and information are for
inspiration and personal use only.

Sweetpea Cardigan

design by
Candi Jensen

Originally published in *Interweave Crochet*, Spring 2006



Chris Hartlowe

FINISHED SIZE 21 (23, 25, 27)" (53.5 [58.5, 63.5, 68.5] cm) chest circumference. Sweater shown measures 23" (58.5 cm).

YARN Nashua Handknits June (100% microfiber; 120 yd [110 m]/134 oz [50 g]; CYCA #3 light): #NJUN005 willow, 4 (5, 5, 6) balls. Yarn distributed by Westminister Fibers.

HOOK Size G/6 (4 mm). Adjust hook size if necessary to obtain the correct gauge.

NOTIONS Tapestry needle; Bucilla 4 mm silk ribbon: #009 lilac, #024 lavender, and #537 coral, 1 card each; Bucilla 7 mm silk ribbon: #566 magenta, 1 card; DMC Pearl Cotton Number 8: #909 very dark emerald green (green), 1 skein; 5 flower buttons ½" (15-mm) diameter in contrasting pastels, two colors.

GAUGE 17 sts and 22 rows = 4" (10 cm) in sc.

SKILL LEVEL Easy.

Back

Ch 49 (53, 57, 61).

Row 1: Sc in 2nd ch from hook and in each

ch across, turn—48 (52, 56, 60) sc.

Row 2: Ch 1, sc in each st across, turn.

Rep Row 2 until piece measures 3½ (4, 4½, 5)" (9 [10, 11.5, 12.5] cm) from beg, ending with a RS row.

Shape armholes:

Row 1: (WS) Ch 1, sc in each of next 44 (48, 52, 56) sts, turn, leaving rem sts unworked.

Row 2: Ch 1, sc in each of next 40 (44, 48, 52) sts, turn, leaving rem sts unworked.

Row 3: Ch 1, sc in each of next 40 (44, 48, 52) sts, turn.

Rep Row 3 until piece measures 7½ (8½, 9½, 10½)" (19 [21.5, 24, 26.5] cm), ending with a WS row. **Shape right neck:**

Row 1: (RS) Ch 1, sc in each of next 11 (12, 13, 14) sts, sc2tog (see Glossary, page 89), turn—12 (13, 14, 15) sts.

Row 2: Ch 1, sc2tog, sc in each st across, turn—11 (12, 13, 14) sts.

Row 3: Ch 1, sc in each st across. Fasten off. **Shape left neck:** Sk center 14 (16, 18, 20) sts and join yarn with sl st in next st.

Row 1: Ch 1, beg in same st as sl st, sc2tog, sc across row, turn—12 (13, 14, 15) sts.

Row 2: Ch 1, sc in each of next 10 (11, 12, 13) sts, sc2tog, turn—11 (12, 13, 14) sts.

Row 3: Ch 1, sc in each st across. Fasten off.

Right Front

Ch 23 (25, 27, 29).

Row 1: Sc in 2nd ch from hook and in each ch across—22 (24, 26, 28) sc, turn.

Row 2: Ch 1, sc in each st across, turn.

Rep Row 2 until piece measures 3½ (4, 4½, 5)" (9 [10, 11.5, 12.5] cm) from beg, ending with a RS row.

Shape armhole:

Row 1: (WS) Ch 1, sc in each of next 18 (20, 22, 24) sts, turn, leaving rem 4 sts unworked.

Row 2: Ch 1, sc in each st across, turn.

Rep Row 2 until piece measures 5½ (6½, 7½, 8½)" (14 [16.5, 19, 21.5] cm) from beg, ending with a WS row.

Shape neck:

Row 1: (RS) Ch 1, sc in each of next 15 (17, 19, 21) sts, turn, leaving rem sts unworked.

Row 2: Ch 1, sc2tog, sc in each st across, turn—1 st dec'd at neck edge.

Row 3: Ch 1, sc in each st across, turn.

Rep Rows 2 and 3 three (four, five, six) more times—11

(12, 13, 14) sc. Work even in sc until right front is same length as back to shoulders. Fasten off.

Left Front

Work as for right front until piece measures 3½ (4, 4½, 5)" (9 [10, 11.5, 12.5] cm) from beg, ending with a WS row. **Shape armhole:**

Row 1: (RS) Ch 1, sc in each of next 18 (20, 22, 24) sts, turn, leaving rem 4 sts unworked.

Row 2: Ch 1, sc in each st across, turn.

Rep Row 2 until piece measures 5½ (6½, 7½, 8½)" (14 [16.5, 19, 21.5] cm) from beg, ending with a RS row.



Shape neck

Row 1: (WS) Ch 1, sc in each of next 15 (17, 19, 21) sts, turn, leaving rem sts unworked.

Row 2: Ch 1, sc2tog, sc in each st across, turn—1 st dec'd at neck edge.

Row 3: Ch 1, sc in each st across, turn.

Rep Rows 2 and 3 three (four, five, six) more times—11 (12, 13, 14) sc. Work even in sc until left front is same length as back to shoulders. Fasten off.

Sleeves

Ch 27 (29, 31, 33).

Row 1: Sc in 2nd ch from hook and in each ch across—26 (28, 30, 32) sc, turn.

Rows 2–4: Ch 1, sc in each st across, turn.

Row 5: Ch 1, 2 sc in first st, sc in each st across to last st, 2 sc in last st, turn—2 sts inc'd.

Rep Rows 1–5 three (four, five, six) more times—34 (38, 42, 46) sts. Work even in sc until piece measures 5½ (6, 6½, 7)" (14 [15.5, 16.5, 17.5] cm). Fasten off.

Finishing

With yarn threaded on a tapestry needle, sew shoulder seams. Positioning last 1" (2.5 cm) of sleeve in armhole, sew sleeves into armholes. Sew sleeve and side seams. Weave in loose ends. **Neck edging:** With RS facing, join yarn to neck front with sl st. Work 2 rows sc evenly spaced around neck, working sc2tog at each shoulder seam. Fasten off. **Front edging:** With RS facing, join yarn at left front neck edge with sl st. Work 3 rows sc evenly spaced along front edge. Sew buttons onto left front edge, placing first button at neck edge and last at



Chris Hartlowe

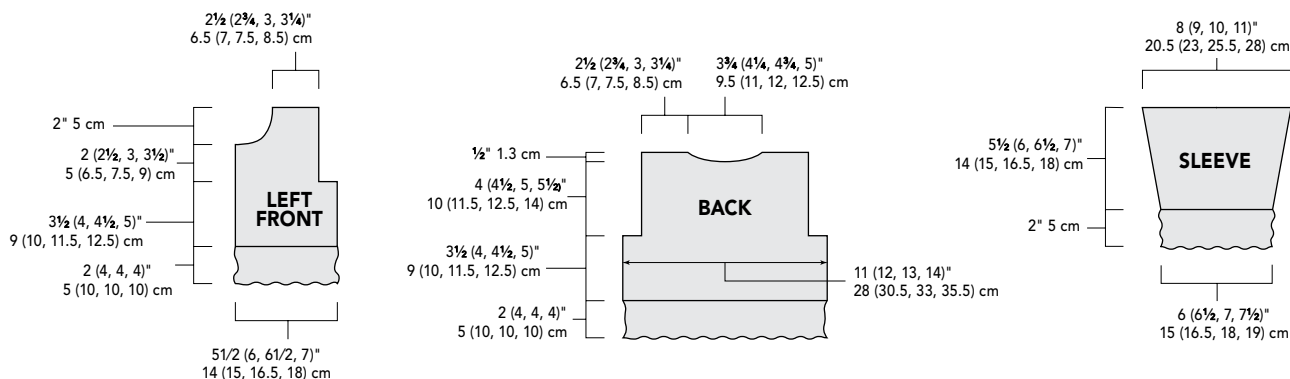

lower edge and spacing 3 more evenly between. With RS facing, join yarn at lower edge of right front and work in sc for 2 rows.

Next row: Work another row of sc, working buttonholes opposite buttons as foll: ch 5, sc in next st. Fasten off. **Embroidery:** Referring to diagram above for color and stitch placement, chain-stitch (see page 29) flower stems from lower edge toward shoulder on fronts and back in Number 8 thread. With silk ribbon, embroider flowers in daisy stitch (see below) and flower centers in French knots (see below).

Bottom lace edging: With RS facing, join yarn to bottom front with sl st and work as foll:

Row 1: Ch 1, sc around bottom edge, inc 5 sts evenly spaced, turn—97 (105, 113, 121) sts.

Row 2: Ch 1, sc in first st, *ch 4, sk 3, sc in next st; rep from * around, ending sc in last st, turn—24 (26, 28, 30) ch-4 sps.

Row 3: Ch 3, sc in center of next ch-4 lp, *ch 4, sc in next ch-4 lp; rep from *, ending ch 3, sc in last sc,

turn.

Row 4: Ch 3 (counts as first dc), dc in ch-3 sp, ch 1, *3 dc in next ch-4 space, ch 1; rep from * across, ending 2 dc in last ch-3 sp, turn.

Row 5: *Ch 4, sc in center dc; rep from * across, turn.

Row 6: Ch 3 (counts as first dc), 2 dc in ch-4 sp, ch 2, *3 dc in each ch-4 sp, ch 2; rep from * across, turn.

Repeat Rows 2–6 zero (one, one, one) more time(s).

Picot row: *Ch 6, sl st in 4th ch from hook, ch 2, sc into next ch-2 sp; rep from *, ending sc in last dc. Fasten off. **Sleeve lace edging:** With RS facing, join yarn to cuff of sleeve with sl st and work sc around bottom edge, inc 3 (1, 3, 1) st(s) evenly spaced, turn—29 (29, 33, 33) sts. Work Rows 2–6 of bottom lace edging once, then work picot row. Fasten off.

CANDI JENSEN is author of *Candy Tots* (Sixth&Spring, 2003), *Candy Babies* and *Candy Blankies* (Sixth&Spring, 2004), a line of crochet pattern books for little ones.

Daisy Stitch

Bring threaded needle out from back to front at center of a stitch. *Form a short loop and insert needle back where it came out. Keeping loop under needle, bring needle back out in center of next stitch over. Beginning each stitch at the same point on the background, repeat from * for desired number of petals (six shown).

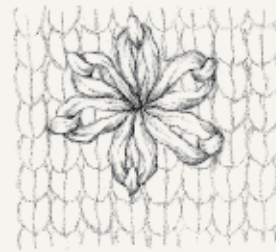

French Knot

Bring needle out of fabric from back to front, wrap yarn around needle one to three times, and use thumb to hold in place while pulling needle through wraps into fabric a short distance from where it came out.



Chain Stitch Embroidery

Bring threaded needle out from back to front at center of a stitch. Form a short loop and insert needle back where it came out. Keeping the loop under the needle, bring needle back out in center of next stitch to the right.



Stella Jacket

design by Heather Lodinsky

Originally published in *150 Knit & Crochet Motifs*
(Interweave 2011)



Do you know a little girl who is one part mischief and one part sugar and spice, with just the right amount of sparkle in her eyes? Well, this jacket is for her. The Asian flair of the frog closures mixed with the bright and fun color combination makes this jacket adorable and fun to wear. The jacket is made from acrylic yarn that is easy to wash and lightweight, making this a versatile jacket that can be worn from spring through fall.

Equipment

YARN: DK weight (#3 Light).

SHOWN: Red Heart, Designer Sport (100% acrylic; 279 yd [255.1 m]/3 oz [85 g]); #3801 aqua ice (MC), 2 (2, 2, 3) balls; #3690 bay leaf (CC), 1 (1, 1, 1) ball.

HOOK: H/8 (5.00 mm) or hook needed to obtain gauge; G/6 (4.25 mm) for Frog Closures.

NOTIONS: Tapestry needle for weaving in ends; spray bottle with water and straight pins for blocking.

Joe Coca

LEFT FRONT

Refer to **Stitch Diagram C** at right for assistance.

Ch 25 (27, 29, 31) with MC.

Row 1(RS): (Sc, dc) in 4th ch from hook (skipped ch count as hdc), *sk 1 ch, (sc, dc) in next ch, rep from * across to last ch, hdc in last ch, turn—24 (26, 28, 30) sts; 11 (12, 13, 14) SR.

Rep Row 2 of csp 18 (20, 24, 26) times.

ARMHOLE OPENING:

Starting with Row 1, follow **Stitch Diagram C** on page 40 for 8 (8, 12, 12) rows, fasten off.

NECK OPENING:

Refer to **Stitch Diagram C** for assistance.

Row 1: Sk 1 (1, 2, 2) sc, join MC with sl st in next sc, ch 2 (count as hdc) cont in csp across to end, turn—16 sts; 7 SR.

Row 2: Cont in csp across to last sc, sc in last sc, turn—14 sts; 6 SR.

Row 3: Sl st in next 3 sts, ch 2 (counts as hdc), cont in csp across to end, turn—5 SR.

Rep Row 2 of csp 3 times, fasten off.

SLEEVE (Make 2)

Ch 39 (39, 47, 47) with MC.

Row 1(RS): (Sc, dc) in 4th ch from hook (skipped ch count as hdc), *sk 1 ch, (sc, dc) in next ch, rep from * across to last ch, hdc in last ch, turn—38 (38, 46, 46) sts; 18 (18, 22, 22) SR.

Rep Row 2 of csp 1 (3, 1, 3) times.

SLEEVE DECREASE:

See **Stitch Diagram D**, at right, for assistance.

Row 1: Sl st in next 3 sts, ch 2 (counts as hdc), cont in csp across to last sc, sc in last sc, sl st in top of tch, turn—16 (16, 20, 20) SR.

Row 2: Sk sl st, sl st in next 2 sts, ch 2 (count as hdc), cont in csp across to end, turn.

Rows 3–9: Rep Row 2 of csp.

Rep Rows 1–9 of Sleeve Decrease 1 (1, 2, 2) times.

Rep Row 1 of Sleeve Decrease once more.

SLEEVE CAP:

Row 1: Rep Row 2 of Sleeve Decrease, turn.

Rep Row 2 of csp 3 (5, 1, 1) times, fasten off.

FINISHING, BLOCKING AND SEAMING

Pin Back, Fronts (Left and Right), and Sleeves to

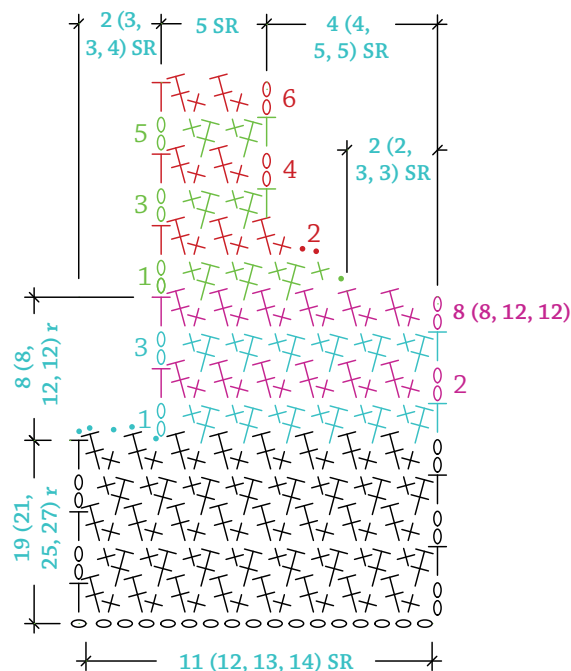

B. RIGHT PANEL SHAPING

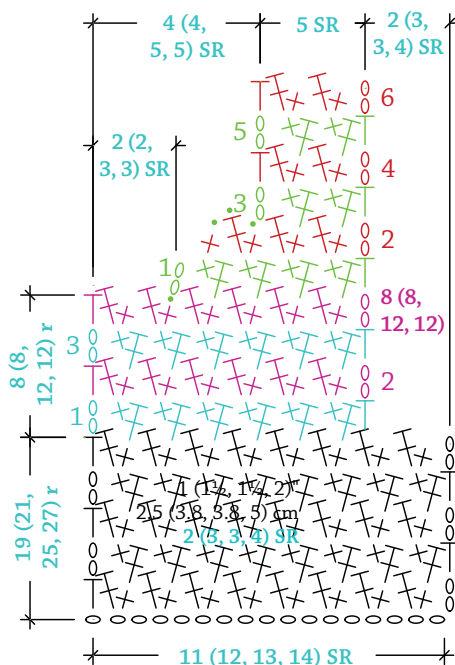

C. LEFT PANEL SHAPING

The Plans

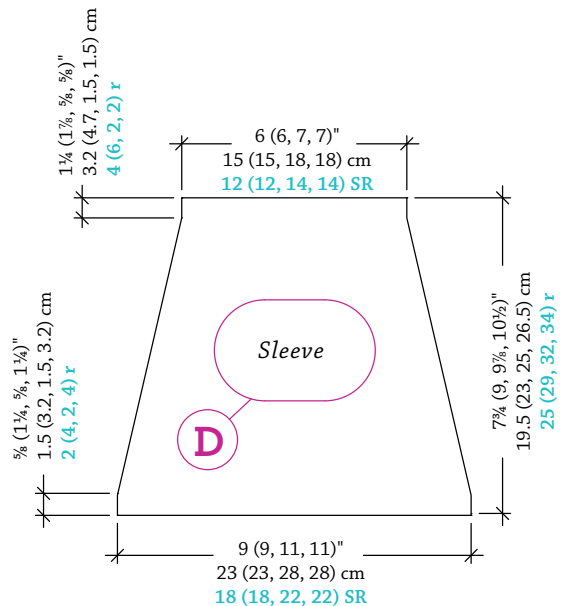
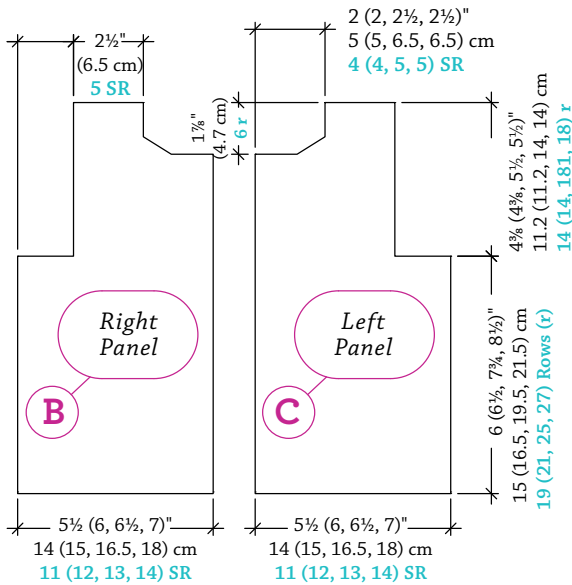
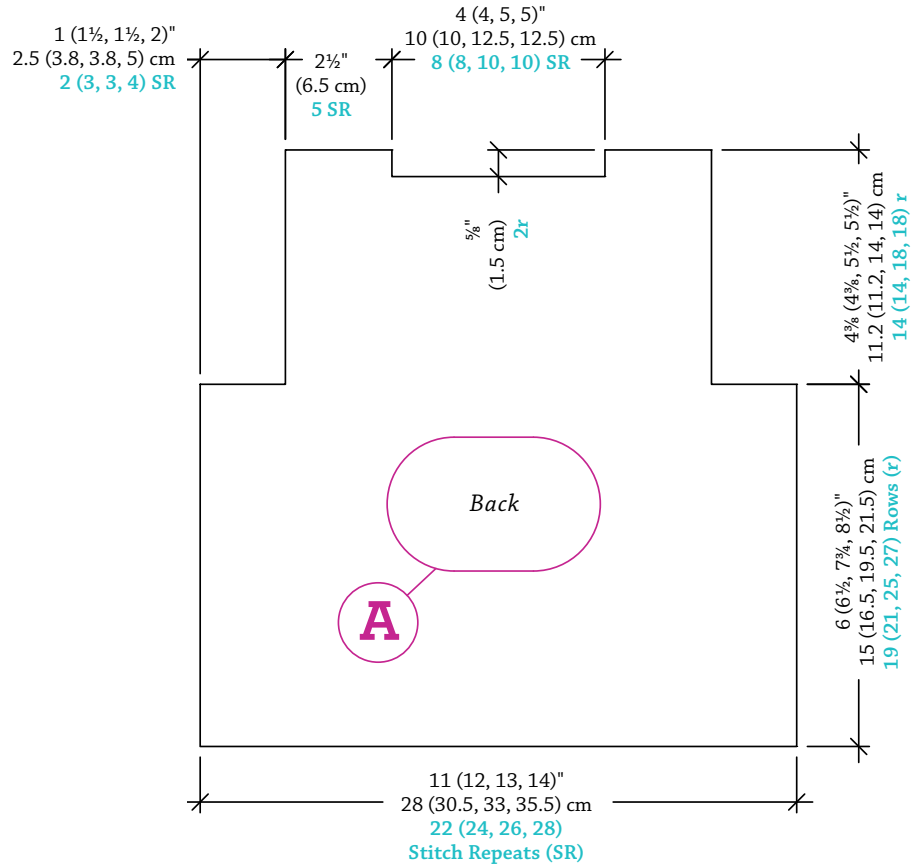

NOTE: If you do not wish to create your own frog closures, simply buy ready-made ones that complement the color of the jacket. Just be sure to choose relatively lightweight closures that are not too chunky or they may droop on the jacket. Use strong, matching sewing thread and a handsewing needle to secure them to the jacket, according to the placement instructions at the end of the Loop Side and Button Side instructions .

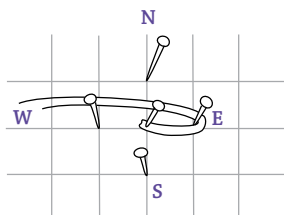

figure 1

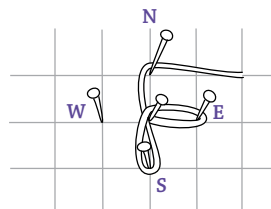

figure 2

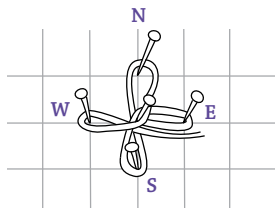

figure 3

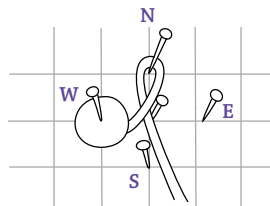

figure 4

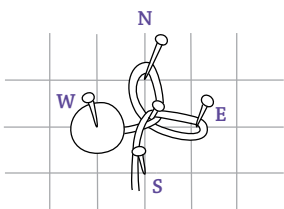

figure 5

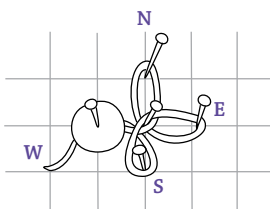

figure 6

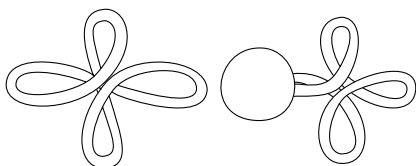

figure 7

schematic size. Spritz with water and allow to dry. Pin RS of Fronts and Back together. Seam shoulders by sl st through both fabrics at once. Pin RS of Sleeves and Front/Back panels together. Whipstitch sleeve and side seams together with leftover yarn. Turn right side out.

COLLAR

Join MC at edge of neck on the RS.

Row 1: Ch 1, sc evenly across neck in an odd number of sts, turn.

Row 2: Ch 1, *sc in next sc, ch 1, sk 1 sc, rep from * across to last sc, sc in last sc, turn.

Row 3: Ch 1, sc in first sc, *sc in next ch-1 sp, ch 1, sk 1 sc, rep from * across to last ch-1 sp, sc in last ch-1 sp, sc in last sc, turn.

Row 4: Ch 1, sc in first sc, *ch 1, sk 1 sc, sc in next ch-1 sp, rep from * across to last sc, ch 1, sc in last sc, turn.

Rep Rows 3–4 three times. Rep Row 3 once, fasten off.

EDGING

Join CC at edge of back on the RS.

Row 1: Ch 1, sc evenly across body, 3 sc at edge of body and front panel edge, turn work 90 degrees, sc evenly up Front panel and Collar, 3 sc at edge of Collar, turn work 90 degrees, sc evenly across Collar, 3 sc at edge of opposite Front panel, turn work 90 degrees, sc evenly down Front panel, 3 sc at edge of body, turn work 90 degrees, sc evenly across body to first sc, sl st in first sc, do not turn.

Row 2: Ch 1, rev sc in each sc around entire edge, sl st to first rev sc, fasten off, weave in ends.

FROG CLOSURES

LOOP SIDE (MAKE 2):

Ch 44 with G/6 (4.25 mm) hook and CC, sl st in ea ch across to end, fasten off leaving a long tail (minimum of 18" [45.5 cm]) for sewing. *Place 2 pins horizontally into a blocking surface, 1½" (3.8 cm) apart in N/S direction*. Place 2 pins horizontally into the blocking surface 2¼" (5.5 cm) apart in E/W direction, creating an even "diamond" shape as shown in **figure 1**. Pin one end of chain in the center of the pins. Loop other end around E (right) pin in a counterclockwise direction (**figure 1**). Loop end around center pin and then around S (bottom) pin in counterclockwise direction. Tuck end under previous loop at center and then loop end around N (top) pin in clockwise direction (**figure 2**). Loop end around center



Row 6: Sl st in 2nd ch from hook and in each ch back to button, fasten off, leaving long tail (minimum of 18" [45.5 cm]) for sewing.

Squish button flat. Using tapestry needle and long tail, secure button flat by sewing through center multiple times. Repeat instructions from * to * of Loop Side to place N/S (vertical) pins on blocking surface. Place one pin 1½" (2.8 cm) to the E (right) of the center. Place one pin in the center. Pin button off center slightly, towards the W (left) direction. Loop end around N (top) pin in counterclockwise direction. Tuck end under ch at center (**figure 4**). Loop end around E (right) pin in counterclockwise direction and over ch at center pin (**figure 5**). Loop end around S (bottom) pin in counterclockwise direction and tuck end under center. Pin end to back of button (**figure 6**). Pin center of closure securely together. Remove pins from blocking surface, leaving securing pins in place on closure. Turn closure over. With tapestry needle, secure center of closure with long tail by stitching through all layers (make sure your stitches are small enough on the RS of the closure so that they do not show; see **figure 7**). Whipstitch button side of closure to the RS of fabric, directly across from corresponding loop side.

ROBYN CHACHULA is the author of *Blueprint Crochet* and *Mission Falls Goes to Crochet*. Her designs have been published in magazines including *Interweave Crochet* and *Crochet Today!* and several books including *Interweave Presents Crocheted Gifts*. She has also designed for yarn companies and has appeared as a guest on *Knit and Crochet Today* and *Knitting Daily TV*. She lives in Pittsburgh, Pennsylvania.

pin and then W (left) pin in clockwise direction. Tuck end under work at center (**figure 3**). Pin center of closure securely together. Remove pins from blocking surface, leaving center securing pins in place on closure. Turn closure over. With tapestry needle, secure center of closure with long tail by stitching through all layers (**figure 7**; make sure your stitches are small enough on the RS of the closure so that they do not show). Weave in opposite end. With tapestry needle and long end, whipstitch loop side of closure to the RS of fabric using photo on page 36 as a general guide.

BUTTON SIDE (MAKE 2):

With CC, make adjustable ring, ch 1.

Rnd 1: Sc 4 times in ring, pull ring closed, pm in last st, do not join, working a spiral, moving m up as work progresses, do not turn.

Rnd 2: 2 sc in next sc and in each sc around, do not turn—8 sc.

Rnd 3: Sc in each sc around, do not turn.

Rnd 4: *Sc2tog over next 2 sc, rep from * around, do not turn—4 sc.

Rnd 5: Sc4tog over next 4 sc (button created), ch 35, turn.

Toddler Poncho

design by Candi Jensen

Originally published in *Interweave Crochet SIP* (Interweave 2005)



Chris Hartlowe

Candi Jensen's designs are often inspired by the children in her neighborhood. Bright colors and easy shaping are hallmarks of her work, and this poncho is no exception. Worked in rounds in soft washable wool accented with two fluffy pom-poms, the project is quick enough to complete in a weekend. All the pint-sized princesses in your life will find the poncho the perfect accessory for their tiaras and gowns.

Finished Size

NECK OPENING 18" (45.5 cm) in circumference.

BOTTOM OPENING 36" (91.5 cm) in circumference.

LENGTH 11" (28 cm).

YARN Cascade 220 Superwash (100% wool; 220 yd [201 m]/31/2 oz [100 g]): #833 red (MC), and #836 pink (CC), 1 ball each.

HOOK SIZE H/8 (5 mm). Adjust hook size as necessary to obtain the correct gauge.

NOTIONS Tapestry needle.

Gauge 12 sts = 4" (10 cm); first 4 rows in patt = 2" (5 cm).

SKILL LEVEL Easy.

Stitch Guide

BOBBLE: (Yo, insert hook in next st, yo, draw yarn through st, yo, draw through 2 loops on hook) 3 times in same st, yo, draw through all 4 loops on hook.

SHELL (sh): 3 dc in same st.

Poncho

With MC, ch 52 and join with sl st in first ch, taking care not to twist chain.

Rnd 1: (RS) Ch 2 (counts as first hdc), hdc in each ch around, sl st in 2nd ch of beg ch to join, turn—52 sts.

Rnd 2: (WS) Ch 4 (counts as dc, ch 1), skip next st, sh (see Stitch Guide) in next st, ch 1, skip next st, *dc in next st, ch 1, skip next st, sh in next st, ch 1, skip next st; rep from * around, sl st in 3rd ch of beg ch to join, turn—13 sh; 78 sts.

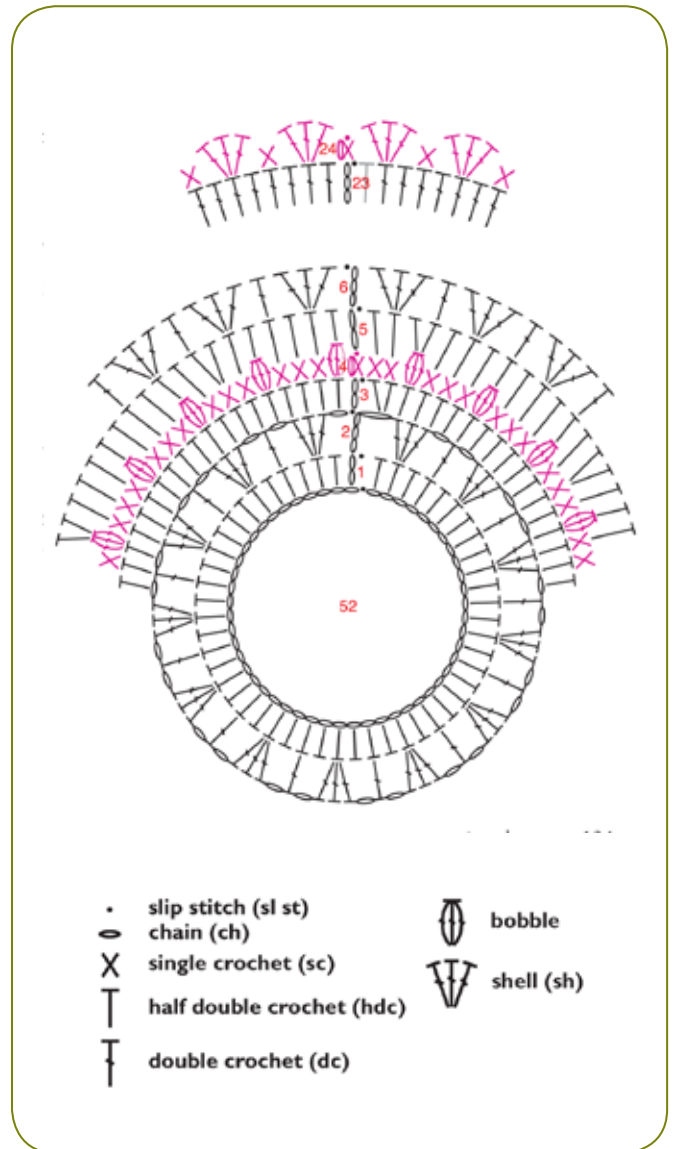

Rnd 3: Ch 2 (counts as first hdc), hdc in each of next 37 sts, 2 hdc in next st, hdc in each of next 38 sts, 2 hdc in next st, sl st in 2nd ch of beg ch to join, turn—80 sts. Fasten off MC, join CC.

Rnd 4: With CC, ch 1, *sc in next 3 sts, bobble (see Stitch Guide) in next st; rep from * around, sl st in first sc to join, turn—20 bobbles; 80 sts. Fasten off CC, join MC.

Rnd 5: With MC, ch 2 (counts as first hdc), hdc in each of next 8 sts, 2 hdc in next st, *hdc in each of next 9 sts, 2 hdc in next st; rep from * around, sl st in 2nd ch of beg ch to join, turn—88 sts.

Rnd 6: Ch 3 (counts as first dc), skip next st, sh in next st, skip next st, dc in next st, skip next st, sh in next st, skip next st; rep from * around, sl st in 3rd ch of beg ch to join—22 sh; 88 sts.

Rnd 7: Ch 2 (counts as first hdc), hdc in each st around, sl st in 2nd ch of beg ch to join—88 sts.

Rnd 8: Rep Rnd 4—22 bobbles.

Rnd 9: Ch 2 (counts as first hdc), hdc in each of next 9 sts, 2 hdc in next st, *hdc in each of next 10 sts, 2 hdc in next st; rep from * around, sl st in 2nd ch of beg ch to join, turn—96 sts.

Rnd 10: Rep Rnd 6—24 sh; 96 sts.

Rnd 11: Ch 2 (counts as first hdc), hdc in each of next 10 sts, 2 hdc in next st, *hdc in each of next 11 sts, 2 hdc in next st; rep from * around, sl st in 2nd ch of beg ch to join, turn—104 sts.

Rnd 12: Rep Rnd 4—26 bobbles; 104 sts.

Rnd 13: Ch 2 (counts as first hdc), hdc in each of next 11 sts, 2 hdc in next st, *hdc in each of next 12 sts, 2 hdc in next st; rep from * around, sl st in 2nd ch of beg ch to join, turn—112 sts.

Rnd 14: Rep Rnd 6—28 sh; 112 sts.

Row 15: Ch 3 (counts as first dc), dc in each st around, sl st in 3rd ch of beg ch to join, turn—112 sts.

Rnds 16–23: Rep Rnds 14 and 15 four times. Fasten off MC, join CC.

Rnd 24: With CC, ch 1, *sc in st, skip next st sh in next st, skip next st; rep from * around, sl st in first sc to join—28 sh; 112 sts. Fasten off.



Chris Hartlowe

Drawstring

With CC, make a 36" (91.5-cm) ch. With CC, make two 2½" (6.5-cm) pom-poms (see Glossary, page 102).

Weave drawstring over and under the sts in Rnd 1. Tie 1 pom-pom to each end of drawstring.

CANDI JENSEN is author of *Candy Tots* (Sixth&Spring, 2003), *Candy Babies* and *Candy Blankies* (Sixth&Spring, 2004), a line of crochet pattern books for little ones.

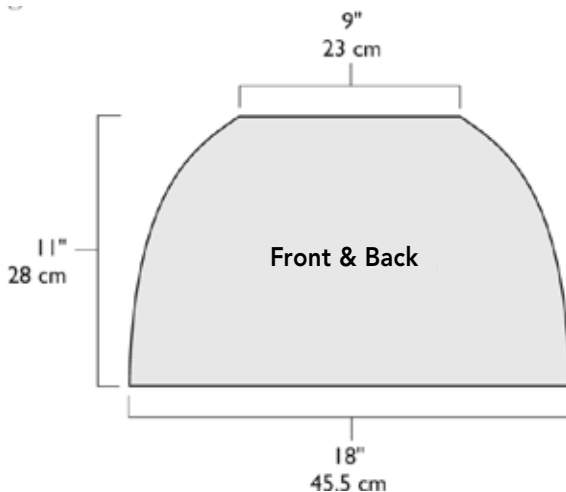

Seashell and Posies Dress

design by *Elissa Sugishita*

Originally published in *Interweave Crochet* (Interweave, Spring 2007)



Kathryn Martin

This dress is worked in a circle from the bottom all the way up. It requires minimal sewing—only at the shoulder seams. A unique flower trim at the waist complements the beautiful shell pattern of the skirt.

FINISHED SIZE 22 (24, 26)" chest circumference, to fit 9–18 months (18–24 months, 2–3 years). Dress shown measures 24".

YARN Tahki Cotton Classic (100% cotton; 108 yd [100 m]/134 oz [50 g]): #3938 lavender (MC), 6 (6, 7) skeins; #3713 green (CC), 1 skein.

HOOK SIZE E/4 (3.5 mm). Adjust hook size if necessary to obtain the correct gauge.

NOTIONS Four (four, five) 1/2" buttons; yarn needle; sewing needle and thread. Gauge 24 sts and 13 rows = 4" in sh patt; 20 sts and 10 rows = 4" in dc.

SKILL LEVEL Intermediate.

Stitch Guide

Dc3tog (double decrease): [Yo, insert hook in next st, yo, draw up a lp, yo draw through 2 lps] 3 times, yo, draw through all lps on hook—2 sts dec'd.

Dc2tog: [Yo, insert hook in next st, yo, draw up a lp, yo, draw through 2 lps] 2 times, yo, draw through all lps on hook—1 st dec'd.

Rnd 3: Ch 4 (counts as dc, ch 1), 2 dc in same ch as sl st, ch 1, sk ch-2 sp, sc in next sc, *ch 1, sk ch-2 sp, 4-sh in next dc, ch 1, sk ch-2 sp, sc in next sc; rep from * around, ending with ch 1, sk last ch-2 sp, dc in same ch as beg, sl st in 3rd ch of tch to join, turn.

Rnd 4: Ch 3, sk 2 dc, sk ch-1 sp, dc in first sc, *ch 2, sk ch-1 sp, sk 2 dc, sc in next ch-1 sp, ch 2, sk 2 dc, sk ch-1 sp, dc in next sc; rep from * around, ending with ch 2, sc in last ch-1 sp, sl st in first ch of tch to join, turn.

Rep Rnds 1–4 for patt.

Trim Stitch Pattern (trim st patt; see stitch diagram, page 66):

Row 1: Ch 1, sc in first st, *ch 5, sk 3 sts, sc in next st; rep from * around, ending with ch 2, dc in first sc (counts as ch-3 sp). Do not turn.

Row 2: Ch 1, sc in ch-3 sp, *ch 3, sc in next ch-5 sp, ch 4, 3-cl (see Stitch Guide) in 4th ch from hook, ch 5, sl st in 3-cl to form ring, (ch 3, 2-cl [see Stitch Guide] into ring, ch 3, sl st into ring) 3 times, (ch 3, 3-cl) into ring, sc in next ch-5 sp; rep from * around, omitting last sc of final rep, sl st in first sc to join.

Notes

The skirt, waistline, and trim of this dress are worked in the round. The body is worked back and forth, beginning at the center-back opening, up to the armholes. The front and back are then divided and worked separately.

Skirt

With MC, ch 168 (192, 208). Sl st in first ch to form ring, being careful not to twist ch. Work in sh patt (see Stitch Guide) for 8 (9, 10)", ending with Rnd 4 of sh patt. **Next rnd:** Work Rnd 1 of dec sh patt (see Stitch Guide)—126 (144, 156) sts rem. Cont working Rnds 1–4 of dec sh patt until piece measures 10½ (12½, 14½)" from beg, ending with Rnd 2 of dec sh patt. **Shape waist:** Ch 1, sc 104 (112, 120) evenly around, sl st in beg sc to join. Do not turn. Work 2 more rnds in sc. Do not break yarn.

Floral trim: With WS facing, join CC in back lp only (blo) of first sc with sl st. Working in the opposite direction of the previous rnd and blo, work trim st patt (see Stitch Guide and diagram below). Fasten off CC. Turn. **Next row:** (RS) With MC and working through both lps, ch 1, sc in each st to end, sl st in beg sc to join, do not

turn. **Bodice:** Ch 3 (counts as dc), sk first sc, dc in each st around, do not join, turn. Work 3 (3, 5) more rows in dc—104 (112, 120) dc. **Separate front and backs:** (RS) Ch 3 (counts as dc), sk first st, dc in each of next 21 (22, 23) dc, dc3tog (see Stitch Guide), turn—23 (24, 25) dc. **Next row:** Ch 2, sk first dc, dc in next st (counts as dc2tog), dc in each st to end, turn—22 (23, 24) dc. Cont working left back in dc until piece measures 43/4 (5, 5½)" from beg of bodice. Fasten off. **Shape right back:** With WS facing, join yarn in first st at center back with sl st, ch 3 (counts as dc), dc in each of next 21 (22, 23) dc, dc3tog, turn—23 (24, 25) dc. **Next row:** Ch 2, sk first dc, dc in next st (counts as dc2tog), dc in each dc to end, turn—22 (23, 24) dc. Cont working in dc until piece measures same as left back. Fasten off. **Shape front:** With RS facing, join yarn to left front in 3rd (5th, 7th) st from back armhole edge. Ch 2, dc2tog (see Stitch Guide; counts as dc3tog) over next 2 sts, dc in each of next 44 (46, 48) dc, dc3tog, turn. **Next row:** Ch 2, sk first dc, dc (counts as dc2tog) in next st, dc in each dc to last 2 sts, dc2tog—44 (46, 48) sts. Work 1 more row in dc. **Shape right front:** Ch 3 (counts as dc), sk first dc,



Kathryn Martin

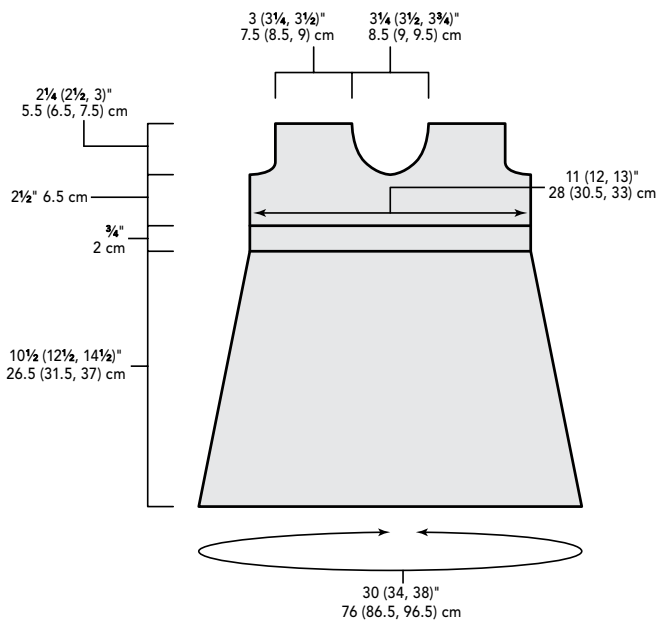

dc in each of next 14 (15, 16) dc, dc3tog, turn—16 (17, 18) dc. Ch 2, sk first dc, dc2tog (counts as dc3tog) over next 2 sts, dc in each dc across, turn—14 (15, 16) dc. Ch 3 (counts as dc), sk first st, dc in each dc to last 2 sts, dc2tog, turn—13 (14, 15) dc. Cont in dc until front measures same as back. Fasten off. **Shape left front:** With RS facing, join yarn in first st of left front with sl st, work as for right front until left front measures same as right front. Fasten off.

Finishing

Join shoulder seam: With RS tog and MC, align front and back shoulder and, working through both thicknesses, sl st layers tog. **Left-back buttonhole band:** With RS facing and MC, join yarn with sl st to

left-back opening at waist, work 2 sc in side of each dc up center-back edge, turn. Next row: Ch 1, sc in first sc, *ch 2, sk 2 sc, sc in each of next 5 sc; rep from * 2 (2, 3) times, sc in each st to end. Fasten off.

Right-back buttonband: With WS facing and MC, join yarn with sl st to right-back opening at waist, work 2 sc in side of each dc up center-back edge, turn. **Next row:** Ch 1, sc in each st to end. Fasten off.

Neck trim: With RS facing and MC, join yarn with sl st to top corner st of left buttonhole band, ch 1, sc around neck opening, working 1 sc per sc and 2 sc in side edge of each dc, ending with an odd number of sts. Fasten off MC.

Next row: Join CC to first st with sl st, ch 1, sc in first st, *ch 3, sk 1 st, sc in next st; rep from * around. Fasten off.

Armhole trim: With RS facing, join MC at underarm with sl st. Ch 1, sc around armhole working 2 sc in side of each dc and ending with an even number of sts, sl st in beg sc to join. Fasten off MC. **Next rnd:** Join CC to first st with sl st, ch 1, sc in first st, *ch 3, sk 1 st, sc in next st; rep from * around, ending with ch 3, sl st in beg sc to join. Fasten off.

Hem: With RS facing, join MC to skirt hem at center back with sl st. Ch 1, sc around bottom of hem working 7 sc between shells and ending with an even number of sts, sl st in beg sc to join. Fasten off MC.

Next rnd: Join CC to first st with sl st, ch 1, sc in first st, *ch 3, sk 1 st, sc in next st; rep from * around, ending with ch 3, sl st in beg sc to join. Fasten off.

Weave in loose ends. Steam-block lightly. Sew buttons to right back opposite buttonholes. Weave in loose ends.

ELISSA SUGISHITA is an avid crocheter and knitter. She has worked in the children's clothing industry and loves designing clothing for herself.

Crochet stylish gifts for year-round giving!

Frog Charming

design by Toni Rexroat

Originally published in Interweave Crochet, Winter 2009

In the story of the Frog Prince, a spoiled princess loses her favorite ball down a well. It is retrieved by a frog prince in exchange for becoming the princess's playmate—to eat with her, play with her, and sleep on her pillow at night. One morning the princess awakens to discover that the frog has been transformed into a handsome prince. Now you can make a frog prince for your own princess.



Joe Coca

FINISHED SIZE: About 21" tall with legs extended.

YARN: Blue Sky Alpacas Dyed Cotton (100% organically grown cotton; 150 yd [137 m]/ 3½ oz [100 g]; **4**): #602 honeydew (A), 2 skeins; #613 ink (B), #614 drift (C), #636 jasper (D), and #638 dandelion (E), 1 skein each.

HOOK: Size G/6 (4 mm). Adjust hook size if necessary to obtain correct gauge.

NOTIONS: Yarn needle; sewing needle and matching thread; corn-based or polyester stuffing.

GAUGE: 15 sts and 7 rows = 4" in dc.

SKILL LEVEL: Intermediate.

Notes

Beg stuffing body, legs, and head just after beg dec. Unless otherwise noted, pieces are worked in a spiral without joining rnds.

Body

With A, ch 4, sl st in first ch to form ring.

Rnd 1: Ch 3 (counts as dc), 13 dc in ring, do not join, place marker (pm) in first st to mark beg of rnd—14 dc.

Rnd 2: 2 dc in each dc around—28 dc.

Rnd 3: *Dc in next dc, 2 dc in next dc; rep from * around—42 dc.

Rnd 4: *Dc in next 2 dc, 2 dc in next dc; rep from * around—56 dc.

Rnds 5–10: Dc in each dc around.

Rnd 11: *Dc in next 2 dc, dc2tog (see Glossary); rep from * around—42 dc.

Rnd 12: Dc in each st around.

Rnd 13: *Dc in next dc, dc2tog; rep from * around—28 dc.

Rnd 14: Dc2tog to m—14 dc.

Rnd 15: Dc2tog to m, hdc in next st, sc in next st—7 st. Fasten off.

Head

Work as for body through Rnd 4.

Rnd 5: *Dc in next 3 dc, 2 dc in next dc; rep from * around—70 dc.

Shape mouth:

Rnd 6: Pm in 24th st, *2 dc in next dc, dc in next 2 dc; rep from * to m, move m up, dc to end—78 dc.

Rnd 7: *Dc2tog, dc in next 2 dc; rep from * to m, dc to end—70 dc.

Rnd 8: *Dc in next 3 dc, dc2tog; rep from * around—56 dc.

Rnd 9: *Dc in next 2 dc, dc2tog; rep from * around—42 dc. Stuff head.

Rnd 10: *Dc in next dc, dc2tog; rep from * around—28 dc.

Rnd 11: Dc2tog around—14 dc. Fasten off.

Eye (make 2)

Note

Eyes are worked in joined rnds. With B, ch 4, sl st in first ch to form ring.

Rnd 1: Ch 2 (counts as dc), 7 dc in ring, sl st in beg ch-2 changing to C in last st—8 dc.

Rnd 2: Ch 2, dc in first dc, 2 dc in each dc around, sl st in beg ch-2 to join—16 dc.

Rnd 3: Ch 2, dc in first dc, dc2tog around, sl st in beg ch-2 to join—8 dc. Stuff eye.

Rnd 4: Ch 2, dc2tog around, sl st in beg ch-2 to join—4 dc. Fasten off.

Arm (make 2)

Hand: With A, ch 10.

Rnd 1: Dc in 4th ch from hook (3 skipped chs do not count as dc), dc in next 5 ch, 4 dc in last ch, working across back of chain, dc in next 5 back ridge lps, 3 dc in last ch, pm in first dc to mark beg of rnd—18 dc.

Rnd 2: Dc in next 7 dc, dc2tog, dc in next 7 dc, dc2tog—16 dc.

Rnd 3: Dc2tog, dc in next 4 dc, dc2tog 2 times, dc in next 4 dc, dc2tog—12 dc.



Joe Coca

Arm: Dc in each dc until arm measures 7". Stuff arm.

Next rnd: Dc2tog around. **Next rnd:** Dc2tog to last dc, dc in last dc. Fasten off, leaving a long tail for sewing.

Leg (make 2)

With A, ch 4, sl st in first ch to form ring.

Rnd 1: (RS) Ch 3 (counts as dc), 11 dc in ring, do not join, pm in first dc—12 dc.

Work even in dc until leg measures 6½", do not fasten off.

Foot:

Rnd 1: *2 dc in next dc, dc in next dc; rep from * around—18 dc.

Rnd 2: 2 dc in each of next 7 dc, dc in next 11 dc—25 dc. Stuff leg.

Rnd 3: Dc2tog, 4 dc in next dc, *dc4tog (see Glossary), 4 dc in next dc; rep from *, dc2tog, dc in next 10 dc—26 dc.

Rnd 4: Dc2tog around—13 dc.

Rnd 5: Dc2tog to last dc, dc in last dc. Fasten off.

Crown

With E, ch 36, sl st in first ch to form ring.

Rnds 1–2: Ch 2 (counts as dc), dc in each ch around—36 dc.

First point:

Row 1: Ch 2 (counts as first dc), dc in next 4 dc, dc2tog, turn—6 dc.

Row 2: Ch 2 (does not count as st throughout), dc in next 2 dc, dc2tog—3 dc.

Row 3: Ch 2, dc2tog. Fasten off.

Next point: *With RS facing, sk next 2 dc, join in next dc.

Row 1: Ch 2 (counts as first dc), dc in next 4 dc, dc2tog—6 dc.

Row 2: Ch 2 (does not count as st throughout), dc in next 2 dc, dc2tog—3 dc.

Row 3: Ch 2, dc2tog. Fasten off.

Rep from * 2 times.

Bowtie

With D, ch 8, sc in 2nd ch from hook and each ch across, turn.

Rows 1–12: Ch 1, sc across—7 sc.

Middle wrap: Ch 4, sc in 2nd ch from hook and each ch across—3 sc. Rep last row 6 times. Wrap middle wrap around bowtie and sl st ends tog.

Neck band: With D, ch 4. **Next row:** Sc in 2nd ch from hook and each ch across—3 sc. Rep last row

to length needed to wrap around frog's neck. Sew bowtie to neckband.

Ball

With D, ch 4, sl st in first ch to form ring.

Rnd 1: Ch 2 (counts as dc), 7 dc in ring, pm in first dc to mark beg of rnd—8 dc.

Rnd 2: 2 dc in each dc around—16 dc.

Rnd 3: *Dc in next dc, 2 dc in next dc; rep from * around—24 dc.

Rnd 4: *Dc in next 2 dc, 2 dc in next dc; rep from * around changing to E in last dc—32 dc.

Rnds 5–6: Dc around changing to D in last st of Rnd 6.

Rnd 7: *Dc in next 2 dc, dc2tog; rep from * around—24 dc. Stuff ball.

Rnd 8: *Dc in next dc, dc2tog; rep from * around—16 dc.

Rnd 9: Dc2tog around—8dc.

Rnd 10: Dc2tog around—4 dc. Fasten off.

Finishing

Using A, sew body to head. Using sewing thread, sew eyes to head and limbs to body. Using B and backstitch (see Glossary) embroider mouth. Position bowtie around neck and sew ends tog. Weave in loose ends.

TONI REXROAT is the editor for *Crochet Me*. When not working she is busy dreaming of ways to make fairy tales come to life. Visit her blog at CrochetMe.com.



hand
picked
for you

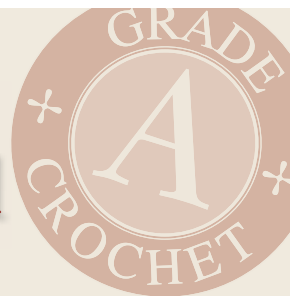

Marcy Smith's 20 most popular patterns

Top designers of the first six years of *Interweave Crochet* showcase their designs and expert advice in one highly sought-after collection.



The Best of Interweave Crochet
A Collection of Our Favorite Designs
Marcy Smith
160 pages, 8 1/2 x 9, \$24.95, pb
ISBN: 978-1-59668-302-0

 **INTERWEAVE**
interweavestore.com

Glossary

Abbreviations

beg	begin(s); beginning	rem	remain(s); remaining
bet	between	rep	repeat; repeating
blo	back loop only	rev sc	reverse single crochet
CC	contrasting color	rnd(s)	round(s)
ch(s)	chain	RS	right side
cm	centimeter(s)	sc	single crochet
cont	continue(s); continuing	sk	skip
dc	double crochet	sl	slip
dec(s)('d)	decrease(s); decreasing; decreased	sl st	slip(ped) stitch
est	established	ss	slip stitch
fdc	foundation double crochet	sp(s)	space(es)
flo	front loop only	st(s)	stitch(es)
fol	follows; following	tch	turning chain
fsc	foundation single crochet	tog	together
g	gram(s)	tr	treble crochet
hdc	half double crochet	WS	wrong side
inc(s)('d)	increase(s); increasing; increased	yd	yard
k	knit	yo	yarn over hook
lp(s)	loop(s)	*	repeat starting point
MC	main color	**	repeat all instructions between asterisks
m	marker	()	alternate measurements and/or instructions
mm	millimeter(s)	[]	work bracketed instructions a specified number of times
patt(s)	pattern(s)		
pm	place marker		
p	purl		

Glossary

Crochet Gauge

To check gauge, chain 30 to 40 stitches using recommended hook size. Work in pattern stitch until piece measures at least 4" (10 cm) from foundation chain. Lay swatch on flat surface. Place a ruler over swatch and count number of stitches across and number of rows down (including fractions of stitches and rows) in 4" (10 cm). Repeat two or three times on different areas of swatch to confirm measurements. If you have more stitches and rows than called for in instructions, use a larger hook; if you have fewer, use a smaller hook. Repeat until gauge is correct.

Slip Stitch Crochet (sl st)

Insert hook into stitch, yarn over hook and draw loop through stitch and loop on hook.



Crochet Chain (ch)

Make a slipknot on hook. Yarn over hook and draw it through loop of slipknot. Repeat, drawing yarn through the last loop formed.



Single Crochet (sc)

Insert hook into a stitch, yarn over hook and draw a loop through stitch, yarn over hook (Figure 1) and draw it through both loops on hook (Figure 2).



Figure 1



Figure 2

Double Crochet (dc)

*Yarn over, insert hook into a stitch, yarn over and pull a loop through stitch (three loops on hook; Figure 1), yarn over and draw it through two loops (Figure 2), yarn over and draw it through the remaining two loops (Figure 3). Repeat from *.



Figure 1

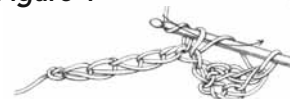

Figure 2



Figure 3

Treble Crochet (tr)

*Wrap yarn around hook two times, insert hook into a stitch, yarn over and pull a loop through (four loops on hook; Figure 1), yarn over and draw it through two loops (Figure 2), yarn over and draw it through the next two loops, yarn over and draw it through the remaining two loops (Figure 3). Repeat from *.



Figure 1

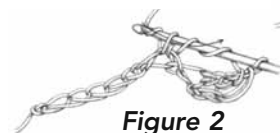

Figure 2



Figure 3